

# ***BRICK MOULDINGS***

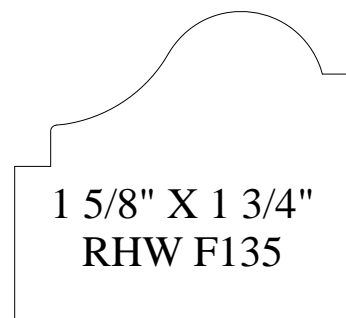

# ***BRICK MOULDINGS***

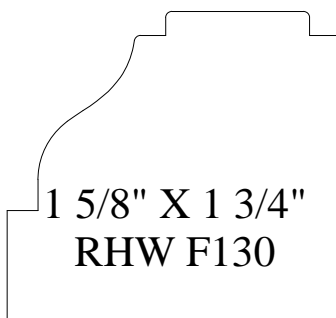
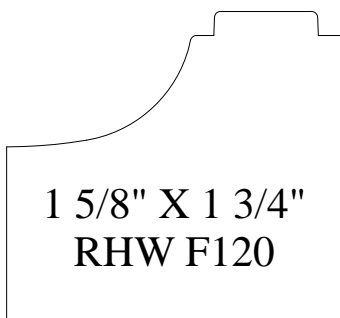
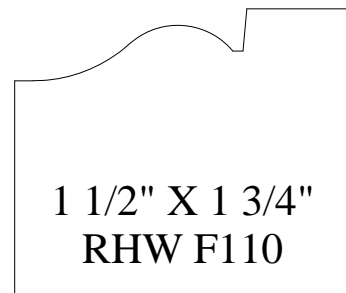
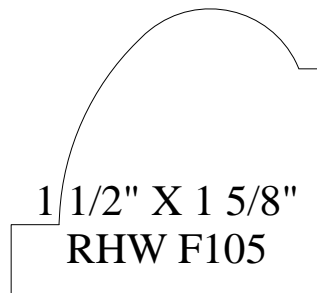
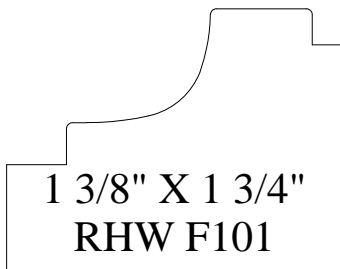
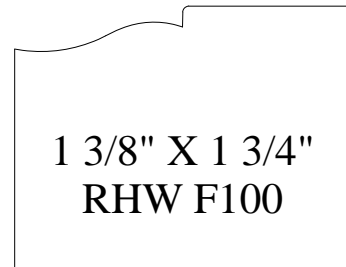
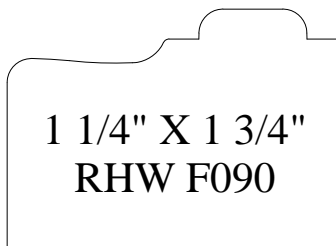
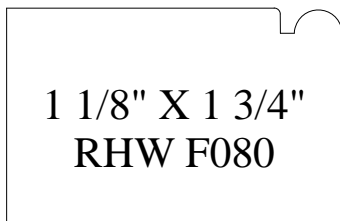
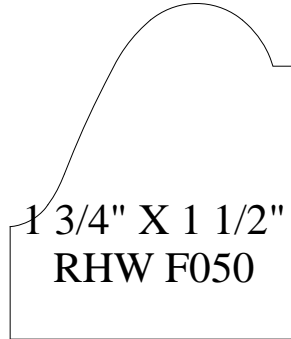
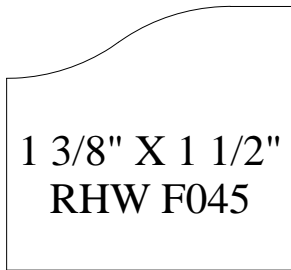
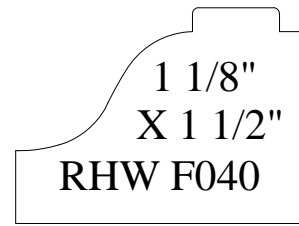
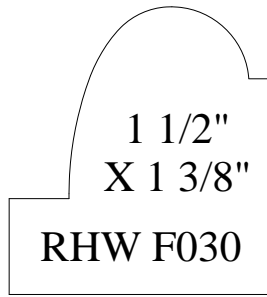
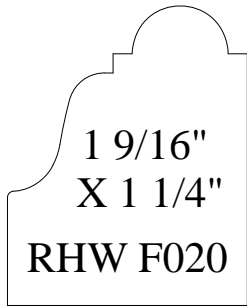
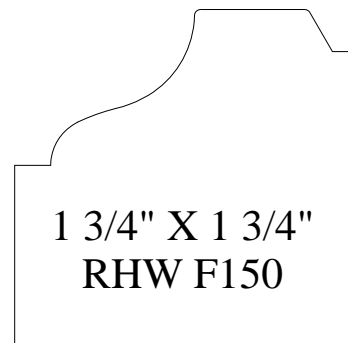
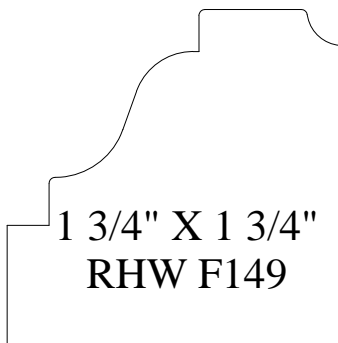
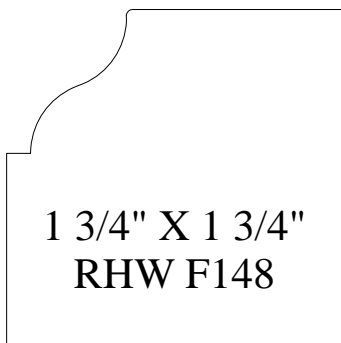
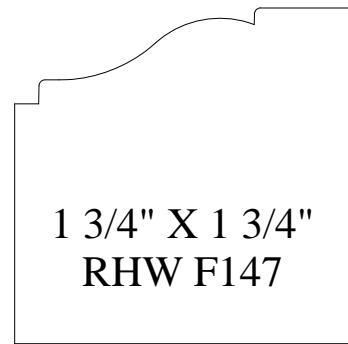
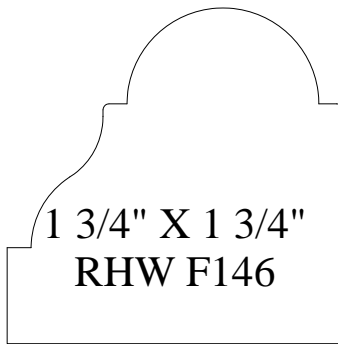
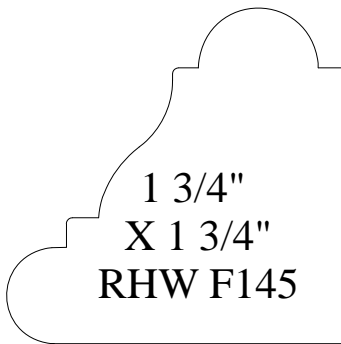
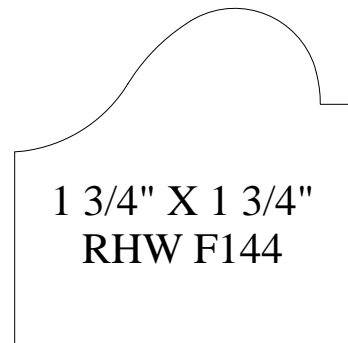
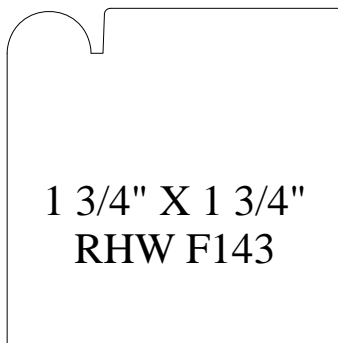
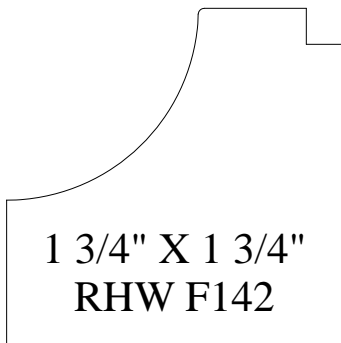
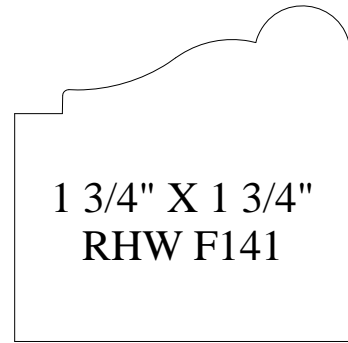
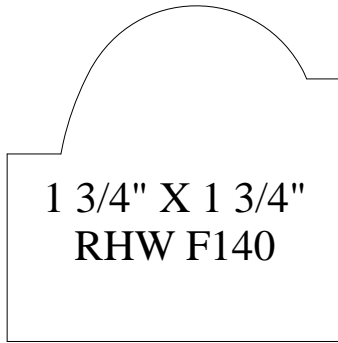
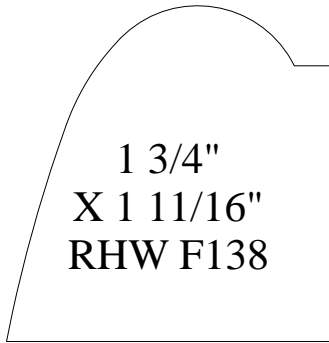

# ***BRICK MOULDINGS***

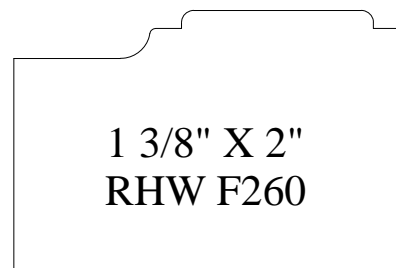
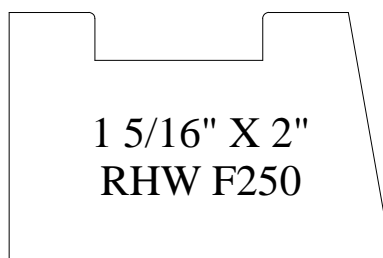
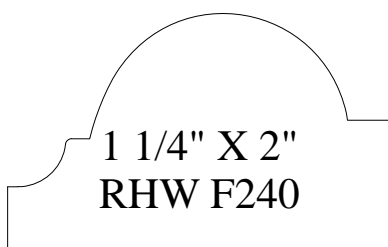
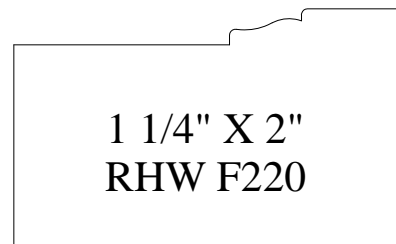
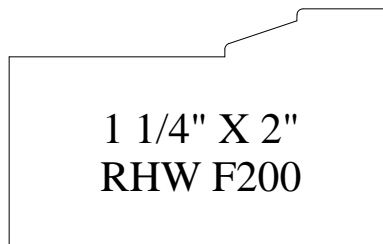
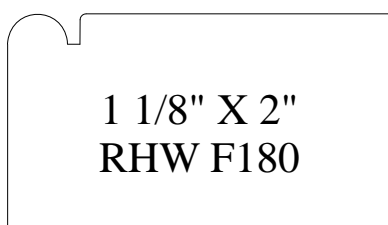
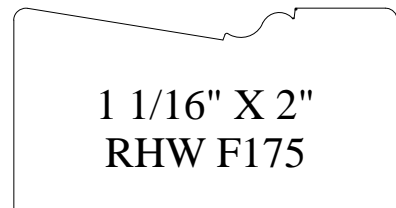
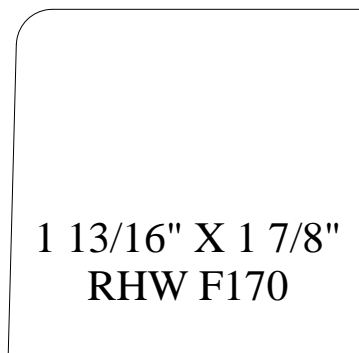
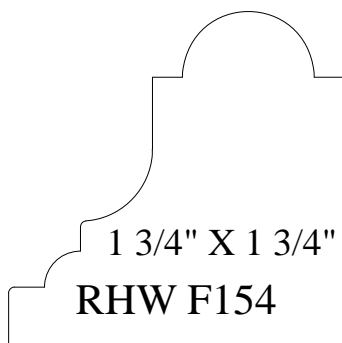
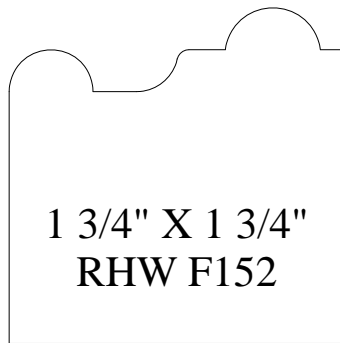
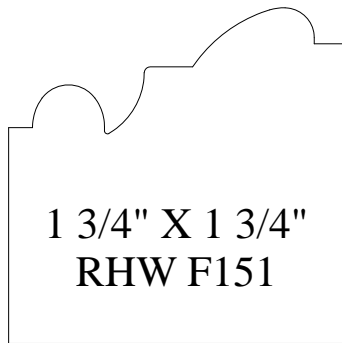

# ***BRICK MOULDINGS***

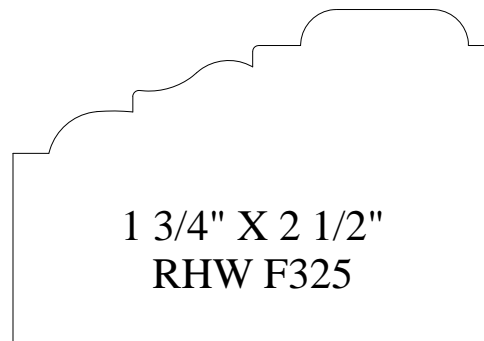
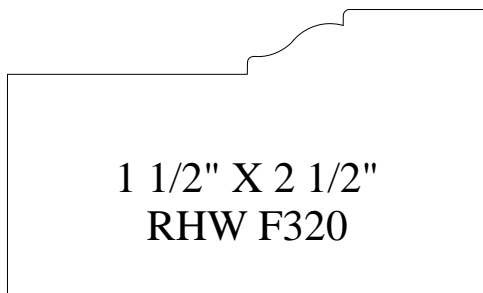
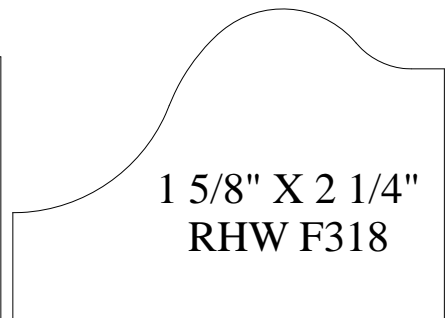
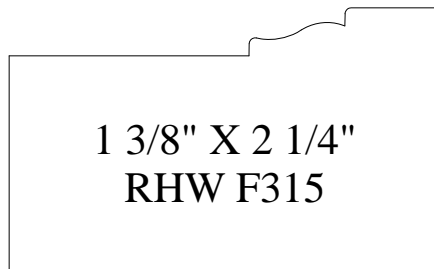
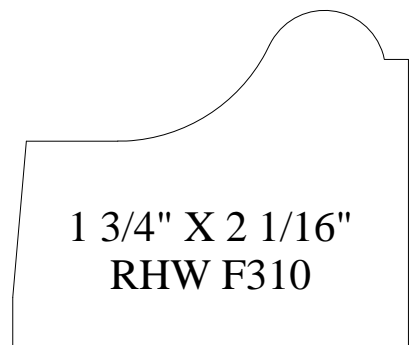
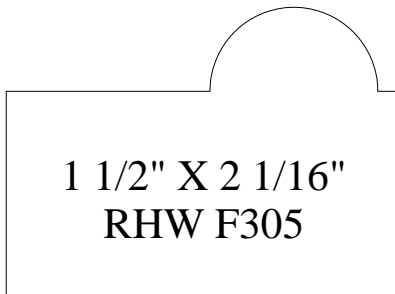
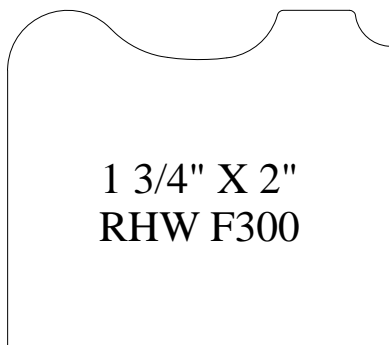
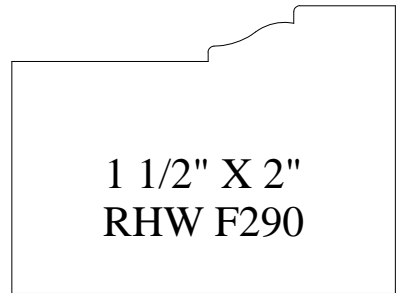
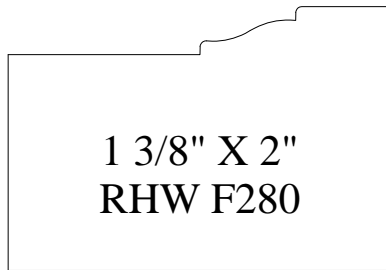
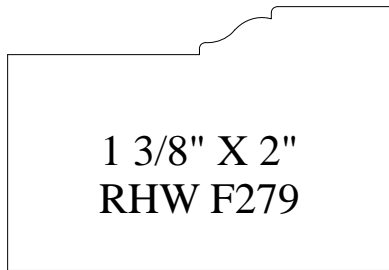

# ***BRICK MOULDINGS***

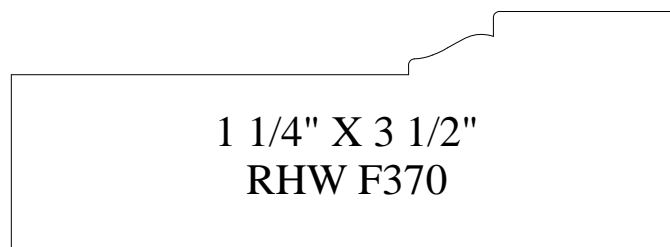
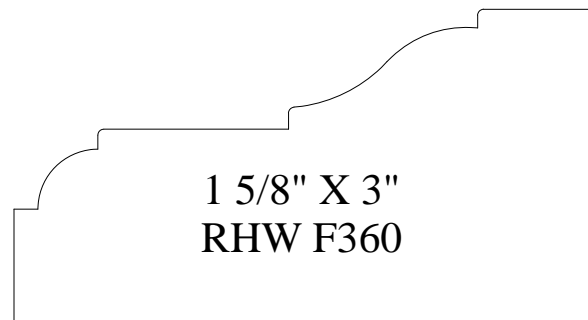
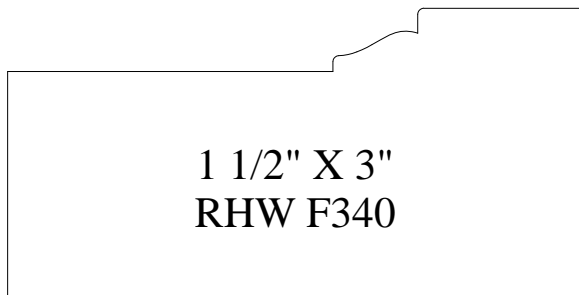
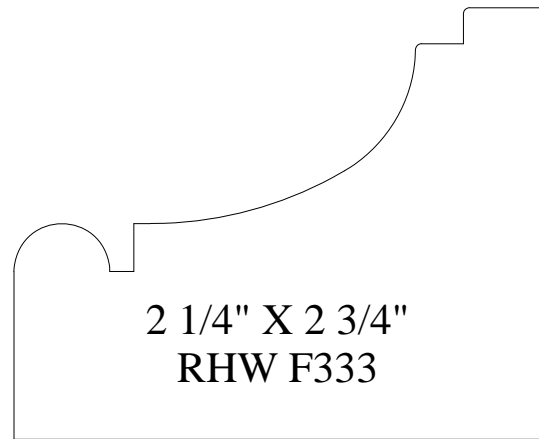
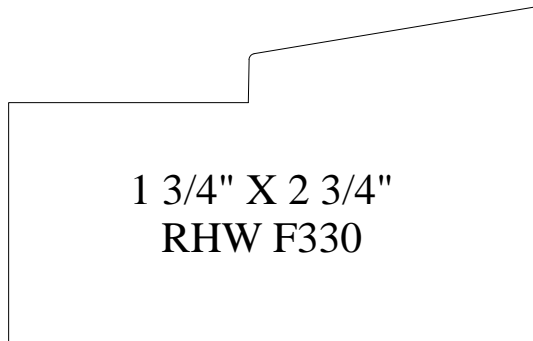

# ***BRICK MOULDINGS***

